

E202
(Tuya WiFi)

Smart Lock User Manual

Please read this manual carefully before use

Information & Safety Warnings

Note: Please prepare a Phillips screw driver and 4 AA batteries before installation.

1. Keep your fingers clean before using this product.
2. In original settings, it can be unlocked with any fingerprint, any card, or password `1234567890` ended with `#`.
3. Unlock: Press registered fingerprint on front handle sensor, or make card close to lock pad, or enter password ended with "#".
4. If the power is insufficient, there will be an alarm prompt, and the lock can be only unlocked around 50 times, please replace with 4 new batteries in time. When batteries power running out, connecting a power bank with Micro USB line though Emergency Power Port can unlock, but the APP network function will be failure.
5. Please don't use corrodent material to clean the surface.
6. When the password/fingerprint/card/APP can not unlock the door, please use the key to unlock the door. Please keep the emergency key with you or put it in outdoor safe place.
7. Waking up lock needs around 3 seconds or more, when long time no using.
8. The lock is suitable for 1.57 ~3.94INCH thick doors.
9. Work temperature range: -22°F ~ 131°F.

Features

1. The total capacity of system is 100, and the first three are administrator.
2. Touching button, durable.
3. Support 6-8 password and 20 virtual password.
4. Support low power warning.
5. Support volume adjustment and door bell.

Name	Parameter
Fingerprint Sensor	semiconductor
DPI	500
Identify Time	0.3S
Unlock Way	Fingerprint, Card, Password, Key and APP
System Capacity	100
Supply Voltage	6V
Low Voltage Warning	4.8V
Standby Current	<=50uA

Installation

1. Installation Instructions

- a. It is recommended to look for professionals to install, watch the video carefully before installing.
- b. Please note that the connection line can't be pressed or folded during installation.
- c. Before the installation, the lock must be selected correctly according to the door opening direction, because the handle can't be adjusted.
- d. While installing, the door must be in half open state until the commissioning is completed.
- e. After the installation is completed, when the fingerprint, card, password(1234567890) and #, APP, key unlock, test whether the front handle and back handle unlock/lock normally or not.
- f. If it does not work properly, please check if there is improper installation or the power cord is loose.

2. Installation Overview

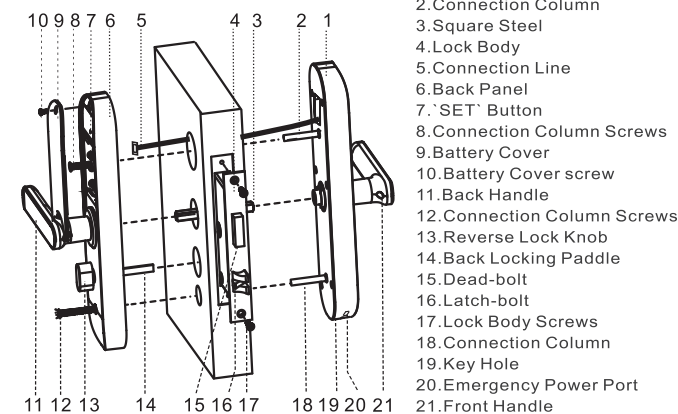

3. Confirm The Direction of The Door

This smart lock is suitable for Left Out/Left In/Right Out/Right In) 4 kinds of door opening directions.

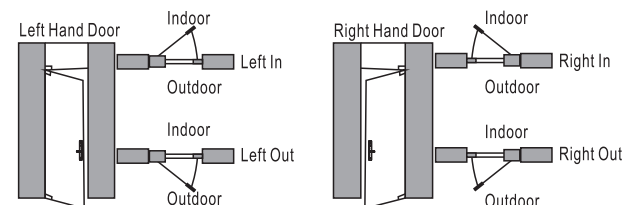

4. Open Hole

Please refer to the opening hole drawing, and drill right holes on the door.

5. Install Lock Body

- 5.1. Choose the installation direction of the latch-bolt of the lock body by the door opening directions.



Left In/
Right Out



Left Out/
Right In

- 5.2. Change the direction of lock body

- a. Push the reversing block to the other side.
- b. Push the latch-bolt into the lock and turn 180 degrees.
- c. Put back the reversing block, and the latch-bolt will pop up automatically.

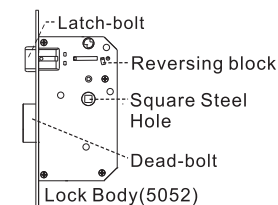

- 5.3. Put the lock body into the door frame and tighten 2 fixing screws.

6. Choose The Parts

Choose suitable parts according to the following table.

Door thickness	Square Steel Length	Connection Column Length	Connection Column Screw Length
1.57-2.16 Inch	3.15 Inch	1.38 Inch	1.18 and 1.97 Inch
2.17-2.36 Inch	3.15 Inch	2.17 Inch	1.18 and 1.97 Inch
2.76-3.15 Inch	3.94 Inch	2.17 Inch	1.97 and 2.76 Inch
3.55-3.94 Inch	4.72 Inch	2.17 Inch	2.76 and 3.54 Inch
>3.94 Inch(Optional)	5.51 Inch	2.17 Inch	3.54 and 4.33 Inch

7. Install The Lock

7.1. Install 2 connection columns on the front panel.

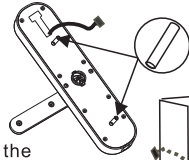

7.2. Install The Front Panel

- Insert the suitable square steel into the lock body.
- Pass the connection line through the door hole.
- Align the square steel with the square steel hole of the front panel and fix the front panel on the door, then press the other end of the square steel.

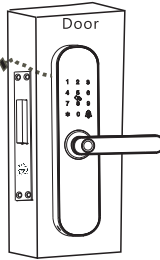

7.3. Install The Back Panel

- Press the front panel, and connect the connection line with the corresponding interface of the back panel, then insert the excess line into the door hole.
- Insert back locking paddle into the lock body, and you can cut off one or two sections of back locking paddle according to the thickness of the door.

Note: The length of back locking paddle does not exceed the thickness of the door.

- Align the square steel with the square steel hole of the back panel, and compress the back panel.
- Lock 2 connection column screws to fix the back panel.
- Install 4 AA batteries and the battery cover, then lock the battery cover screw.

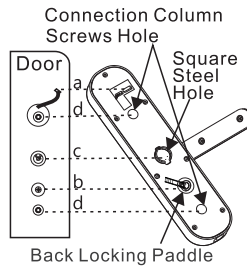

8. Install Buckle Plate And Buckle Box

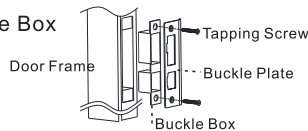

9. Debugging

- Please always keep the door in half open status when debugging.
- Check the following function can be achieved or not.
 - Press down front handle, latch-bolt/dead-bolt remains in locking status.
 - Press down front handle, latch-bolt/dead-bolt retract in unlocking status.
 - Lift up front handle, dead-bolt stretches out in any status.
 - Press down back handle, latch-bolt/dead-bolt retract in any status.
 - Lift up back handle, dead-bolt stretches out in any status.
- When reverse locking from inside, press down front handle/ back handle, latch-bolt/dead-bolt remains.
- Verify other function normal or not, including self locking, virtual password, setting button, APP etc.

Using The Lock

Add The Administrator (The first three are administrator)

- Remove the battery cover, short press 'Set' (back panel) or long press '**', then the voice prompts: 'Please add administrator'.
- Add administrator's fingerprint(3 times), card, or password (6-8 numbers) ended with '#' (the same password, 2 times).
- The voice prompts: 'add successfully'.
- Then you can continue to add.

Notes: 1. The different position fingerprints can be added to improve the fingerprint identification rate.
2. '**': Back, Sign out button, '#': Confirm button.

Add The User

- Remove the battery cover, short press 'Set' (back panel) or long press '**', then the voice prompts: 'Please verify the administrator'.
- Verify the administrator.
- Add user's fingerprint(3 times), card, or password (6-8 numbers) ended with '#' (the same password, 2 times).
- The voice prompts: 'Add successfully'.
- Then you can continue to add.

Delete The User

- Remove the battery cover, short press 'Set' (back panel) or long press '**', then the voice prompts: 'Please verify the administrator'.
- Verify the administrator.
- Short press Set(back panel) or long press '**' again.
- Press '1' to remove all user fingerprints, press '2' to remove all user passwords, press '3' to remove all user cards, press '4' to remove all users.
- The voice prompts: 'successful'.

Note: The administrator can't be removed by doing this.

Reset The Lock

- Remove the battery cover, long press 'Set' for 3 seconds.
- The system restore to the factory default settings.

Notes:

- After the reset, all the information are removed (including administrator).
- The password will return to its default '1234567890'.
- Please add a new administrator immediately.

APP Installation And Network Configuration

- Search 'TuyaSmart' in APP store, download APP.
 - Install and open APP, register and login with the mobile phone number.
 - APP: Press 'My family' / 'Add Device' / 'All Devices' / 'Lock' / 'Confirm indicator rapidly blink', then select WiFi network, enter WiFi password.
 - Short press '3'+ '#' of the lock, Verify the administrator.
 - Network configuration: the LED of '8' fast flash, please add network in APP.
 - Refer to the operation prompt to complete the network configuration of APP.
 - Add successfully: The voice prompts 'add successfully'.
 - Add failure: LED light show 'X' and the voice prompts 'add failure', please try again.
- Notes:
- This APP supports only 2.4Ghz WiFi network.
 - The WiFi connected to the APP and mobile phone should be stay in same.
 - Make sure one of the administrators is a password.
 - The remote to open the door:
 - Press '4' and '#' to activate in the lock.
 - Press the icon of 'Click open remotely', when it flash.

Self-locking

If the password is entered wrong for 5 times continuously, the system will be locked for 180 seconds, and the fingerprint or card unlock can remove self-locking.
If the fingerprint is entered wrong for 8 times continuously, the system will be locked for 180 seconds, and the card unlock can remove self-locking.

Low Power Warning

When the battery power is lower than 4.8V, the lock will prompt 'The battery is use up, please replace it', please replace with 4 new batteries in time.

Virtual Password

Enter virtual password before or after the real password, it can be unlocked.

Volume Adjustment :Press '3' '3' '3' '#' to switch(Mute, Low, Medium, High).
Door Bell: Press '#' in LED off state.

FCC Statement:

This device complies with Part 15 of the FCC Rules. Operation is subject to the following two conditions:

- (1) This device may not cause harmful interference, and
- (2) This device must accept any interference received, including interference that may cause undesired operation.

Warning: Changes or modifications not expressly approved by the party responsible for compliance could void the user's authority to operate the equipment.

Note: This equipment has been tested and found to comply with the limits for a Class B digital device, pursuant to Part 15 of the FCC Rules. These limits are designed to provide reasonable protection against harmful interference in a residential installation. This equipment generates uses and can radiate radio frequency energy and, if not installed and used in accordance with the instructions, may cause harmful interference to radio communications. However, there is no guarantee that interference will not occur in a particular installation. If this equipment does cause harmful interference to radio or television reception, which can be determined by turning the equipment off and on, the user is encouraged to try to correct the interference by one or more of the following measures:

- Reorient or relocate the receiving antenna.
- Increase the separation between the equipment and receiver.
- Connect the equipment into an outlet on a circuit different from that to which the receiver is connected.
- Consult the dealer or an experienced radio/TV technician for help.

FCC Radiation Exposure Statement:

This equipment complies with FCC radiation exposure limits set forth for an uncontrolled environment. This equipment should be installed and operated with minimum distance 20cm between the radiator & your body.